

PAST QUESTIONS AND ANSWERS

GENERAL METAL WORK (191-1)

MAY/JUNE 2005

1a. Define Drilling

Drilling is defined as the process or method of creating or originating hole in any of the engineering materials, using the drilling machine and the drill bit.

b. List FOUR hand operated drilling appliances

- i. Hand drill
- ii. Portable electric drill
- iii. Hand feed drill press
- iv. Back geared upright drill.

c. Why is a drilling machine termed sensitive drilling machine?

Drilling machine is termed sensitive drilling machine because one can feel all the strains on the drill in the feed handle.

d. Sketch a twist drill and indicate the

- i. Land
- ii. Point angle
- iii. Lip angle
- iv. Web

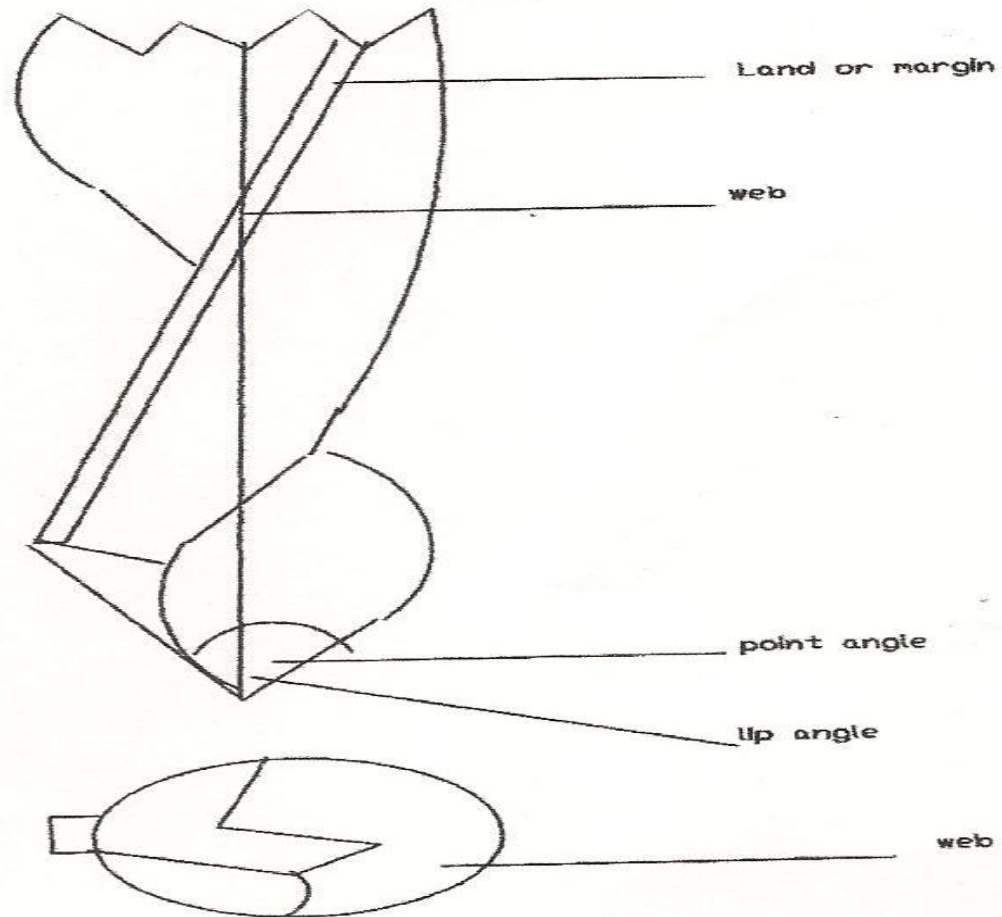

2a. Outline any six protective wears in the work shop

1. Over all
2. Safety Boots
3. Eye goggles
4. Helmet
5. Hand gloves
6. Face shield

b. Name Two types of tool post used on the lath

- i. Single tool post
- ii. Multi-tool post

- c. Make a neat sketch of a four jaw chuck.

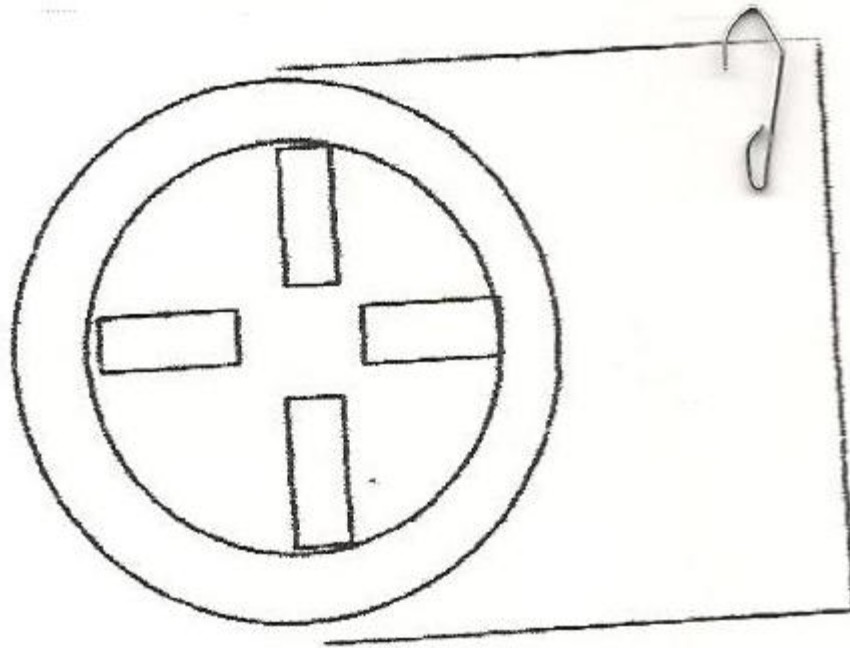

- 3a. Why is it difficult to harden low carbon steel?

It is difficult to harden low carbon steel because of its low carbon content.

- b. What is the differences between tempering and normalizing

Tempering as in heat treatment is done to relives internal strain in harden steel thus increases its toughness. While normalizing in heat treatment is done to relieve internal stresses in steel due to forging, machining or cold work piece.

- c. Define the following:

- i. Annealing
- ii. Normalizing

1. **Annealing:** This is a heat treatment process which is used to produce softening and to improve machinability of hard or hardened steel. It relieves internal stress and strain which may be caused by machining, previous heat treatment or by cold working operations.
2. **Normalizing:** Normalizing is defined as a heat treatment process which relieves internal stresses in steel due to forging, machining or cold-working.

d. Outline the process of case hardening

Case hardening is a surface hardening process which involves hardening the thin surface layer on steel while the inner core remains quite soft. Case hardening process actually involves two important heat treatment phases or steps.

1. Carburizing
2. Hardening

In carburizing, this process involves parking the component to be case hardening a carbon rich materials (container). The container placed in a furnace and heated to the desired temperature. The component then removed and quench in clear water immediately.

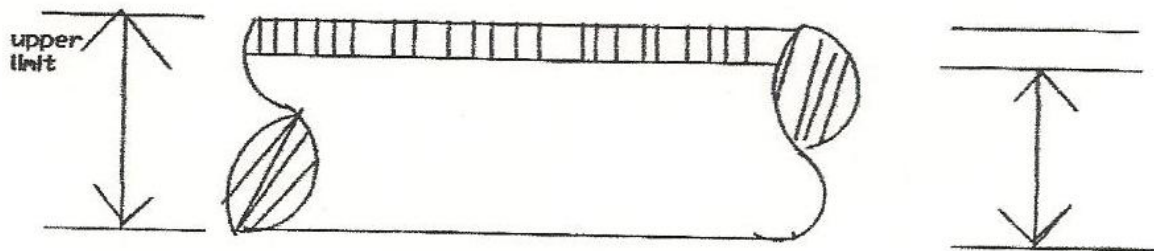

b. Two equal distance holes are to be drilled and removed in a work-piece, briefly explain how to carry out these operations.

- i. The holes are to be marked, located and centre punch
 - ii. Drilled the holes with the required size of drill bit. Having mounted the job on the drilling machine.
3. Select the required size reamer (machine or hand reamer). And gradually reamed.
- c. Explain the operation, turning between centre giving simple sketch.

The operation turning between centre's is carried out on the centre lathe.

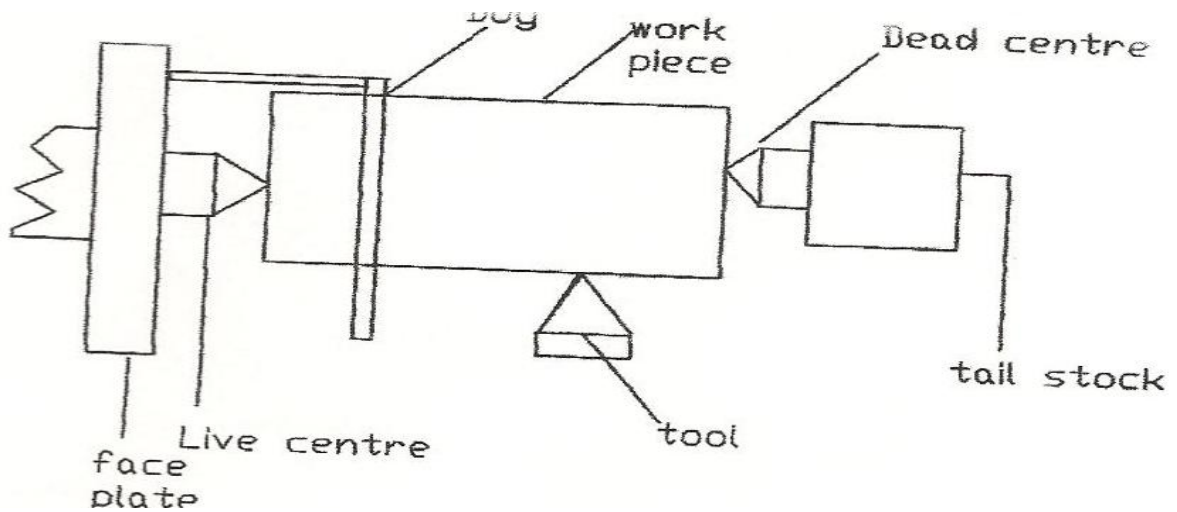

5a. State two differences between a flatter and a set hammer

	Flatter	Set Hammer
1.	Larger face	Smaller face
2.	Used for making hammered surface flat	Used to make square corners and shoulder

b. List THREE types of forging

- i. Hand forging
- ii. Machine forging
- iii. Drop forging

c. With a proportional sketches, describe THREE forging operations.

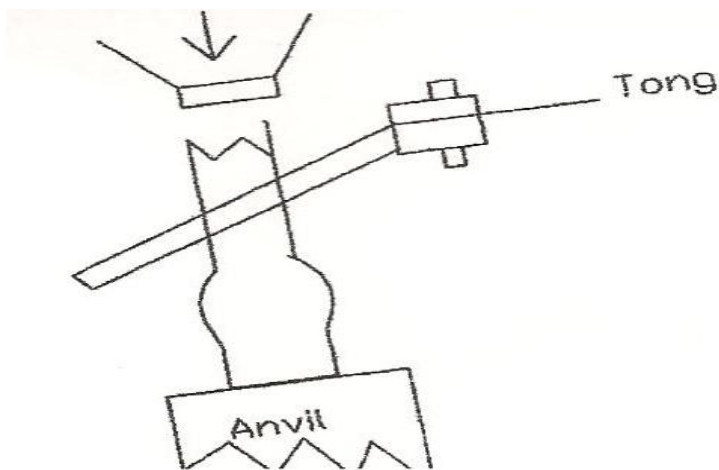

1. Upsetting is a forging operation in which the cross sectional area of the material (work piece) is increased at the expense of the length.

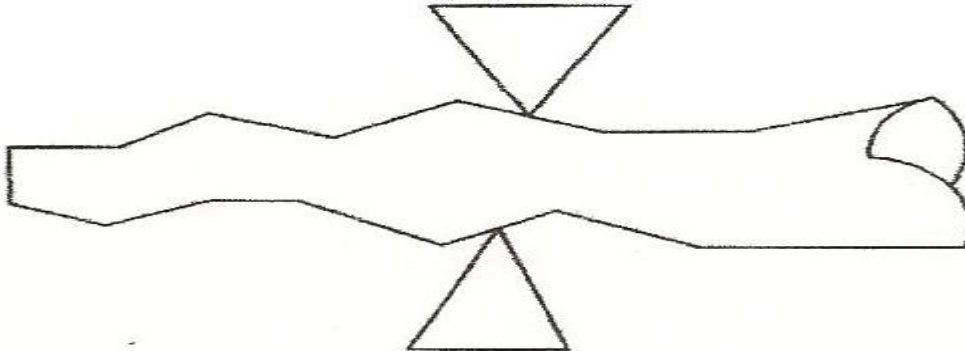

2. Drawing down is a forging operation in which the length of the material (work piece) is increased at the expense of the cross-sectional area.

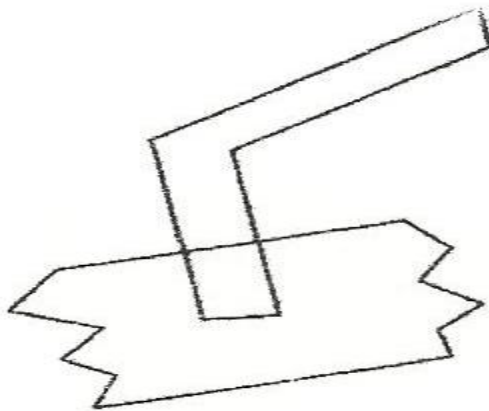

3. Bending: bending a straight rod in a hardy hole

Bending is a forging operation in which the material or work piece are bent to form an angle, eye or you shape e.g. a rod of straight length could be bent to form an L shape as shown above.

6a. Differentiate between arc welding and gas welding with examples.

Arc welding is the fusion of two or more metals together using electricity and electrode. Arc welding is used in joining materials of thick sections. While gas welding is the fusion of two or more metals using gas (oxygen and acetylene) flame to melt or fuse the metal together. Gas welding is used to weld materials of thin sections.

b. Write briefly on the following forging processes.

- i. Upsetting
- ii. Drawing down
- iii. Twisting
- iv. Forming

1. **Upsetting:** This is a forging operation in which the cross-sectional area of the material or work piece is increased at the expenses of the length.
2. **Drawing Down:** This is a forging operation in which the length of the work piece or material is increased at the expense of the of the cross- sectional area.
3. **Twisting:** This is a forging operation in which the length, cross sectional area of the material or work piece is change to form scroll, spirals or twist.
4. **Forming:** Forming is a forging operation in which the shape or length of any material or work piece is change to form a different shape from the original shape e.g. the making of a ring or an eye.